



Overview

PROSTHETIC COMPONENTS AND CADPOSITIONERS

Valid from
December 2022

Prosthetic components and CADPositioners

Implant diameter	Platform	Color coding	Laboratory analog		CADPositioner incl. prosthetic screw ¹		
			Model preparation		BEGO CADAbut Duo Two-piece abutment	BEGO CADAbut Full One-piece abutment	BEGO CADBase Bridge/bar
			Plaster model	3D Model			

Range 0.1 BEGO Implant Systems – Semados® S-implants – Platform Match Design

S 3,25	3,67		56694	549316	57060
S 3,75	3,67		56695		
S 4,1	4,1		56696		
S 4,5	4,5		56698		
S 5,5	5,5		56699		

Range 0.2 BEGO Implant Systems – Semados® Mini-implants

Mini 2,7; 2,9; 3,1	3,5		56982	58256

Range 0.3 BEGO Implant Systems – Semados® MultiPlus – Abutment Niveau

3,25/3,75; 4,1; 4,5; 5,5	MultiPlus		57524	549528	58255

Range 0.5 BEGO Implant Systems – Semados® SC/SCX/S-TG/RS^{Pro}/RSX^{Pro}/RI-implants – Platform Switch Design

RS/RSX 3,0	3,0		57796	549320	58250
SC/SCX/RS ^{Pro} /RSX ^{Pro} 3,25	3,67		58315	549321	58251
SC/SCX/S-TG/RS ^{Pro} /RSX ^{Pro} /RI 3,75	3,67		57819		
SC/SCX/S-TG/RS ^{Pro} /RSX ^{Pro} /RI 4,1	4,1		57820	549322	58252
SC/SCX/RS ^{Pro} /RSX ^{Pro} /RI 4,5	4,5		57821	549323	58253
SC/SCX/RS ^{Pro} /RSX ^{Pro} /RI 5,5	5,5		57822	549324	58254

¹ For single use only.

² DYNAMIC ABUTMENT®¹ screwdriver L24, REF Nr. 549539

Adhesive abutment incl. technician and prosthetic screw

Prosthetic screw²

BEGO CADAbut Duo Two-piece abutment with rotation protection			BEGO CADAbut Duo Two-piece abutment without rotation protection		BEGO CADAbut Full One-piece abutment		BEGO CADBase Bridge/bar	
57285			57286		0°	0°-20°	0°	0°-20°
57287			57288		57031	549530 ²	57031	549530 ²
57289			57290					
57291			57292					
					0°	0°-20°	0°	0°-20°
					56983	56983	56983	549531 ²
					57534			
GH 0	GH 1,5	GH 2,0	GH 0	GH 1,5	0°	0°-20°	0°	0°-20°
		57781			57782	553696		
57823	58370		57827	58374	57031	549530 ²	57031	549530 ²
57824	58371		57828	58375				
57825	58372		57829	58376				
57826	58373		57830	58377				

Prosthetic components and CADPositioners¹

Implant diameter	Platform	Color coding	Laboratory analog		CADPositioner incl. prosthetic screw ²		
			Model preparation		BEGO CADAbut Duo Two-piece abutment	BEGO CADAbut Full One-piece abutment	BEGO CADBase Bridge/bar
			Plaster model	3D Model			

Range 1.1 compatible with Straumann synOcta³







						
3,3; 4,1; 4,8	RN 4,8		520137	4	524880	524880
6,5	WN 6,5		520207	4	524881	524881

Original components: Two-piece abutment on original adhesive abutments.
The required original components (scan build-up, adhesive base) can be obtained from the implant manufacturer.

Range 1.1 compatible with Straumann synOcta (Variobase Abutment)³ – Abutment Niveau

3,3; 4,1 RN	RN synOcta secondary part				524626
4,8	WN synOcta secondary part				524627

Range 1.2 compatible with Straumann BoneLevel³

					
3,3	NC		520277	4	524882
4,1; 4,8	RC		520347	4	524883

Original components: Two-piece abutment on original adhesive abutments.
The required original components (scan build-up, adhesive base) can be obtained from the implant manufacturer.

Range 1.4 compatible with Straumann BLX

				
3,5; 3,75; 4,0; 4,5; 5,0; 5,5; 6,5	RB			
5,0; 5,5; 6,5	WB			

Original components: The required original components (scan build-up, adhesive base) can be obtained from the implant manufacturer.

¹ This symbol is a commercial designation/registered trademark of a company which is not part of the BEGO company group.

² For single use only.



³ CADPositioner from 3Shape¹ usable. Please procure the necessary components from the respective manufacturer.

⁴ DIM analogues by nt-trading¹ usable.

⁵ DYNAMIC ABUTMENT^{®1} screwdriver L24, REF Nr. 549539

Adhesive abutment incl. prosthetic screw



Prosthetic screw²

BEGO CADAbut Duo Two-piece abutment with rotation protection		Spare prosthesis screw		BEGO CADAbut Duo Two-piece abutment without rotation protection		BEGO CADAbut Full One-piece abutment		BEGO CADBase Bridge/bar	
									
		0°				0° 0°-20°		0° 0°-20°	
520134	520135			524338	549534 ⁵	524338	549534 ⁵		
520204									
								524614	
									
		0°		GH 0,7 GH 1,7		0° 0°-20°		0° 0°-20°	
520274	520275	550276	550278	524340	549535 ⁵	524340	549535 ⁵		
520344		550277	550279			520340	549535 ⁵		
									
						0°		0°	
						552689		552689	

Prosthetic components and CADPositioners¹

Implant diameter	Platform	Color coding	Laboratory analog		CADPositioner incl. prosthetic screw ²		
			Model preparation		BEGO CADAbut Duo Two-piece abutment	BEGO CADAbut Full One-piece abutment	BEGO CADBase Bridge/bar
			Plaster model	3D Model			

Range 2.1 compatible with DENTSPLY Implants FRIALIT/XiVe³

					
3,4	3,4	■	520564	4	524868
3,8	3,8	■	520634	4	524869
4,5	4,5	■	520705	4	524870
5,5	5,5	■	520775	4	

Range 2.2 compatible with DENTSPLY Implants Ankylos (Ankylos CX Ti-Interface) – Abutment Niveau

				
3,5; 4,5; 5,5; 7,0	Balance Base Abutment			520813

Original components: Two-piece abutment on original adhesive abutments.

The required original components (scan build-up, adhesive base) can be obtained from the implant manufacturer.

Range 3.1 compatible with Nobel Biocare NobelActive³

					
3,5	NP	■	521068	4	524871
4,3; 5,0	RP	■	521138	4	524872









¹ This symbol is a commercial designation/registered trademark of a company which is not part of the BEGO company group.

² For single use only.

³ CADPositioner from 3Shape¹ usable. Please procure the necessary components from the respective manufacturer.

⁴ DIM analogues by nt-trading¹ usable.









⁵ DYNAMIC ABUTMENT^{®1} screwdriver L24, REF Nr. 549539

Adhesive abutment incl. prosthetic screw			Prosthetic screw ²		
BEGO CADAbut Duo Two-piece abutment with rotation protection	Spare prosthesis screw	BEGO CADAbut Duo Two-piece abutment without rotation protection	BEGO CADAbut Full One-piece abutment	BEGO CADBase Bridge/bar	
					
	0°		0°	0°	0°–20°
520562	520560		520630	520630	549538 ⁵
520632					
520703					
520773					
					
				520820	
					
	0°	GH 0,8 GH 1,8	0°		
521065	521066	550272 550274	524342		
521135	521136	550273 550275	524344		







Prosthetic components and CADPositioners¹

Implant diameter	Platform	Color coding	Laboratory analog		CADPositioner incl. prosthetic screw ²		
			Model preparation		BEGO CADAbut Duo Two-piece abutment	BEGO CADAbut Full One-piece abutment	BEGO CADBase Bridge/bar
			Plaster model	3D Model			

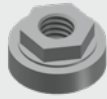

Range 3.2 compatible with Nobel Biocare NobelReplace³

						
3,5	NP		521208	4	524873	
4,0; 4,3	RP		521278	4	524874	
5,0	WP		521348	4	524875	
6,0	6,0				524876	

Range 3.3 compatible with Nobel Biocare Brånemark System³

						
3,3	NP		521488	4	524877	
3,75; 4,0	RP		521558	4	524878	
5,0	WP		521628	4	524879	

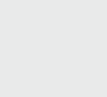
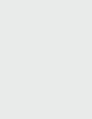
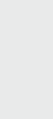
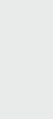
Range 3.4 compatible with Nobel Biocare Multi-unit Abutment – Abutment Niveau

						
Abutment Level	Multi-unit Abutment					521706

Range 4.1 compatible with BIOMET 3i OSSEOTITE Certain/NanoTite Certain³

						
3,25; 3/4/3; 4/3	3,4		522068	4	524860	
4,0; 4/5/4; 5/4	4,1		522138	4	524861	
5,0; 5/6/5; 6/5	5,0		522208	4	524861	
5,0; 5/6/5; 6/5	6,0				524861	

¹ This symbol is a commercial designation/registered trademark of a company which is not part of the BEGO company group.

² For single use only.











³ CADPositioner from 3Shape¹ usable. Please procure the necessary components from the respective manufacturer.

⁴ DIM analogues by nt-trading¹ usable.

⁵ DYNAMIC ABUTMENT^{®1} screwdriver L24, REF Nr. 549539

Adhesive abutment incl. prosthetic screw







Prosthetic screw²

BEGO CADAbut Duo Two-piece abutment with rotation protection	Spare prosthesis screw	BEGO CADAbut Duo Two-piece abutment without rotation protection	BEGO CADAbut Full One-piece abutment	BEGO CADBase Bridge/bar	
					
	0°		0°	0°	0°-20°
521205	521206		524346	524346	549536 ⁵
521275	521276		524348	524348	549537 ⁵
521347					
521415					
					
	0°			0°	
521485	521486			524350	
521555	521556			524351	
521625	521626			524353	
					
				521703	
					
	0°				
522065	522066				
522135					
522205					

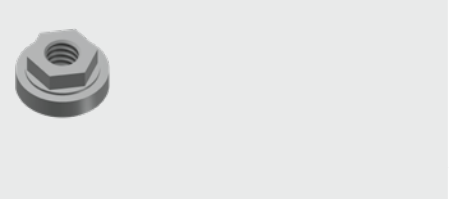

Prosthetic components and CADPositioners¹

Implant diameter	Platform	Color coding	Laboratory analog		CADPositioner incl. prosthetic screw ²		
			Model preparation		BEGO CADAbut Duo Two-piece abutment	BEGO CADAbut Full One-piece abutment	BEGO CADBase Bridge/bar
			Plaster model	3D Model			









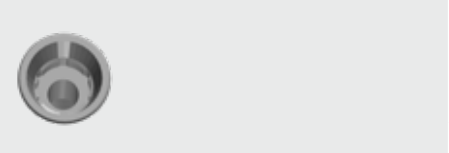

Range 4.2 compatible with BIOMET 3i OSSEOTITE/NanoTite³

				
3,25	3,4		522278 4	524862
3,75; 4.0; 3/4	4,1		522347 4	524863
5,0; 4/5	5,0		522418 4	

Range 5.1 compatible with DENTSPLY Implants ASTRA TECH OsseoSpeed³

				
3,5; 4,0	3,5/4,0		523068 4	524853
4,5; 5,0	3,5/5,0		523138 4	524854

Range 5.2 compatible with DENTSPLY Implants ASTRA TECH OsseoSpeed EV³

				
3,0	3,0		546728 4	524855
3,6	3,6		546729 4	524856
4,2	4,2		546730 4	524857
4,8	4,8		546731 4	524858
5,4	5,4		546732 4	524859

Original components: Two-piece abutment on original adhesive abutments.
The required original components (scan build-up, adhesive base) can be obtained from the implant manufacturer.

Range 5.2 compatible with DENTSPLY Implants ASTRA TECH OsseoSpeed EV³ – Abutment Niveau











3,0; 3,6; 4,2; 4,8; 5,4	Uni Abutment EV			524625
-------------------------	-----------------	--	--	--------

¹ This symbol is a commercial designation/registered trademark of a company which is not part of the BEGO company group.

² For single use only.

³ CADPositioner from 3Shape¹ usable. Please procure the necessary components from the respective manufacturer.

⁴ DIM analogues by nt-trading¹ usable.

Adhesive abutment incl. prosthetic screw			Prosthetic screw ²	
BEGO CADAbut Duo Two-piece abutment with rotation protection	Spare prosthesis screw	BEGO CADAbut Duo Two-piece abutment without rotation protection	BEGO CADAbut Full One-piece abutment	BEGO CADBase Bridge/bar
				
	0°		0°	
522275	522276		524357	
522345				
522415				
				
	0°		0°	
523065	523066		523061	
523135	523136		523131	
				
		GH 1,0 GH 2,0	0°	
550241		550286 550291	524581	
550242		550287 550292	524583	
550243		550288 550293	524585	
550244		550289 550294	524587	
550245		550290 550295	524589	
				524612









Prosthetic components and CADPositioners¹

Implant diameter	Plat- form	Color coding	Laboratory analog		CADPositioner incl. prosthetic screw ²		
			Model preparation		BEGO CADAbut Duo Two-piece abutment	BEGO CADAbut Full One-piece abutment	BEGO CADBase Bridge/bar
			Plaster model	3D Model			

Range 6.1 compatible with Zimmer Dental Tapered Screw-Vent³

							
3,7; 4,1	3,5		523568	4	524885		524885
4,7	4,5		523636	4	524886		524886
6,0	5,7		523706	4	524887		524887

Range 8.1 compatible with CAMLOG CAMLOG SCREW-LINE /ROOT-LINE³

					
3,3	3,3		546734	5	524864
3,8	3,8		546735	5	524865
4,3	4,3		546736	5	524866
5,0	5,0		546737	5	524867
6,0	6,0				

Range 8.1 compatible with CAMLOG CAMLOG SCREW-LINE/PROGRESSIVE-LINE/ROOT-LINE³ – Abutment Niveau

3,3; 3,8; 4,3	Bar Abutment			524629
5,0; 6,0	Bar Abutment			524631
3,8; 4,3	Vario SR Abutment			524634
5,0; 6,0	Vario SR Abutment			524633

Range 8.2 compatible with CAMLOG CONELOG SCREW-LINE³

				
3,3	3,3		524144	549056
3,8	3,8		524193	549057
4,3	4,3			
5,0	5,0		524291	549059

¹ This symbol is a commercial designation/registered trademark of a company which is not part of the BEGO company group.

² For single use only.







³ CADPositioner from 3Shape¹ usable. Please procure the necessary components from the respective manufacturer.

⁴ DIM analogues by nt-trading¹ usable.

⁵ BEGO CADAbut Duo Two piece abutment with rotation protection.

⁶ BEGO CADAbut Duo Two piece abutment without rotation protection.

⁷ The original adhesive base is enclosed.

Adhesive abutment incl. prosthetic screw				Prosthetic screw ²					
BEGO CADAbut Duo Two-piece abutment with rotation protection		Spare prosthesis screw		BEGO CADAbut Duo Two-piece abutment without rotation protection		BEGO CADAbut Full One-piece abutment		BEGO CADBase Bridge/bar	
									
		0°		GH 0,5 GH 1,5				0°	
523565		523566		550280 550283				523638	
523634				550281 550284					
523704				550282 550285					
									
				GH 0,5 GH 1,5		0° 0°-20°		0° 0°-20°	
523920				550258 550262					
523943				550259 550263		524060 549532 ⁶		524060 549532 ⁶	
523966				550260 550264					
523989				550261 550265		524062		524062 549533 ⁶	
524012									
								524618	
								524640	
								524622	
									
GH 0,8 GH 2,0				GH 1,0 GH 2,0					
524145 524146				550266 550269					
524194 524195				550267 550270					
524243 524244				550267 550270					
524292 524293				550268 550271					



Prosthetic components and CADPositioners¹

Implant diameter	Plat- form	Color coding	Laboratory analog		CADPositioner incl. prosthetic screw ²		
			Model preparation		BEGO CADAbut Duo Two-piece abutment	BEGO CADAbut Full One-piece abutment	BEGO CADBase Bridge/bar
			Plaster model	3D Model			

Range 8.3 compatible with CAMLOG iSy (iSy Hybrid Abutment)

Original components: Two-piece abutment on original adhesive abutments.
The required original components (scan build-up, adhesive base) can be obtained from the implant manufacturer.

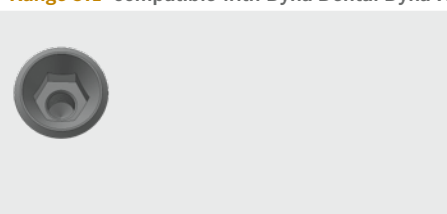
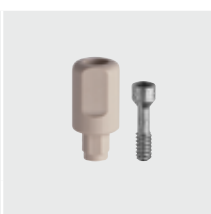
Range 9.1 compatible with Dyna Dental Dyna Helix

					
3,2; 3,6; 4,2; 5,0	3,6/4,0				524379

Range 10.1 compatible with BioComp Implant Level/Abutment Level

					
3,4; 4,0 4,6; 5,2	4,0 5,2				524416

Range 10.1 compatible with BioComp Implant Level/Abutment Level – Abutment Niveau

3,4; 4,0; 4,6; 5,2	Abutment Level				524628
--------------------	----------------	--	--	--	--------





Range 11.1 compatible with NEOSS ProActive

						
3,5; 4,0; 4,5; 5,0; 5,5	4,5		546733	³		524888

¹ This symbol is a commercial designation/registered trademark of a company which is not part of the BEGO company group.

² For single use only.

³ DIM analogues by nt-trading1 usable.

Adhesive abutment incl. prosthetic screw			Prosthetic screw ²	
BEGO CADAbut Duo Two-piece abutment with rotation protection	Spare prosthesis screw	BEGO CADAbut Duo Two-piece abutment without rotation protection	BEGO CADAbut Full One-piece abutment	BEGO CADBase Bridge/bar
				
				0°
				524377
				
				0°
				524413
				525543
				
550300			0°	
			524419	



Prosthetic components and CADPositioners¹

Implant diameter	Platform	Color coding	Laboratory analog		CADPositioner incl. prosthetic screw ²		
			Model preparation		BEGO CADAbut Duo Two-piece abutment	BEGO CADAbut Full One-piece abutment	BEGO CADBase Bridge/bar
			Plaster model	3D Model			

Range 13.1 compatible with BioHorizons Internal³

						
3,0		■		3	549052	
3,5		■		3	549053	
4,5		■		3	549054	
5,7		■		3	549055	

Range 15.1 compatible with Bredent medical Sky

						
3,5	3,5	■	546998	3	546994	
4,0; 4,5; 5,5	4,0	■ ■ ■		3	546996	

Range 16.1 compatible with medentis ICX ICX-Active-Master





						
3,75; 4,1; 4,8	4,0	■	546909	3		546910

¹ This symbol is a commercial designation/registered trademark of a company which is not part of the BEGO company group.

² For single use only.

³ DIM analogues by nt-trading! usable.

Images and illustrations are examples. Colors, symbols, designs, and information on the depicted labels and/or packaging may differ from reality.

Adhesive abutment incl. prosthetic screw			Prosthetic screw ²	
BEGO CADAbut Duo Two-piece abutment with rotation protection	Spare prosthesis screw	BEGO CADAbut Duo Two-piece abutment without rotation protection	BEGO CADAbut Full One-piece abutment	BEGO CADBase Bridge/bar
				
550303				
550296				
550297				
550298				
				
550301				
550302				
				
550299			0°	
			546908	



www.bego.com

BEGO Medical GmbH

Wilhelm-Herbst-Str. 1 · 28359 Bremen, Germany
Tel. +49 421 2028-200 · Fax +49 421 2028-174
E-Mail cadcam@bego.com · www.bego.com

Always want to have a look at all BEGO news?
Sign up for our newsletter here: www.bego.com/newsletter



Please note that not all our products and services are available throughout the world, depending on authorities' approvals. For more information, please consult your local BEGO representative. Errors and changes excepted. Our deliveries of products and services are governed by our Standard Terms of Business (STB), which are available at any time at www.bego.com and will be sent upon request.